

Keyboard designed with Multifunction keys
KFK-EB9HB, -EC0HB, -EC4HB

(PC-AT Compatible 104, 105, 109 Keys + Multifunction 15 keys)

FEATURES

1. USB compliant keyboard designed for Windows® 98/2000.
2. Convenient multi-function keys(15 keys)
3. Meets rigorous safety standards in all countries.
 Certified to comply with FCC part 15 class 'B' limits.
 Also UL, cUL, TÜV, and CE standard.
4. Quiet sound, with a real key touch feeling.
5. Laser printed characters can be recycled in order to protect the environment.
6. Straight cord with USB type connector included.
7. Adjustable tilt mechanism.

* "Windows®" is registered trademark of Microsoft corp.
 "PC-AT" is registered trademark of International Business Machines corp.



SPECIFICATIONS

Item	Specifications
Keyboard Inclination	Step sculpture type
Key Row Offset	9.50-4.75-9.50mm (Keypitch 19.00)
Key Travel	4.2mm
Interface	USB Support USB1.1 & HID1.1
Supply Current	Current: 100mA max.

DIMENSIONS

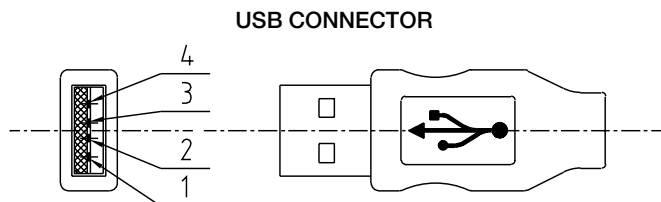
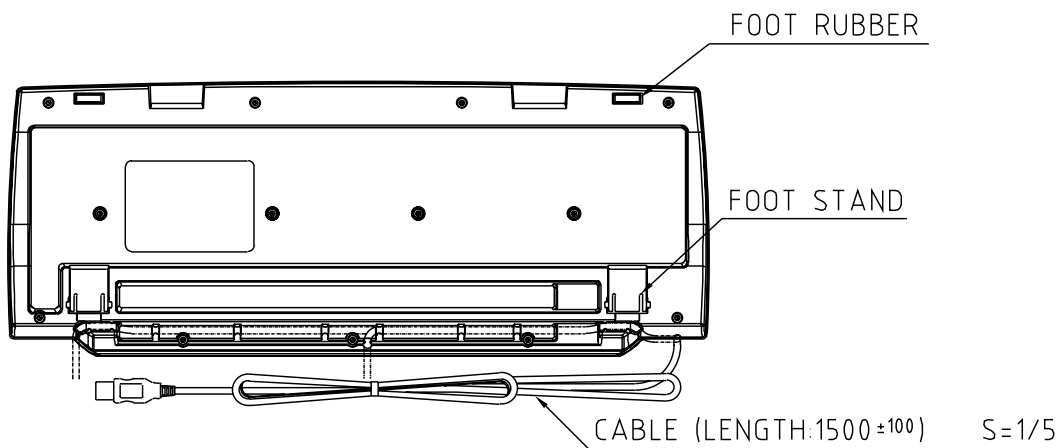
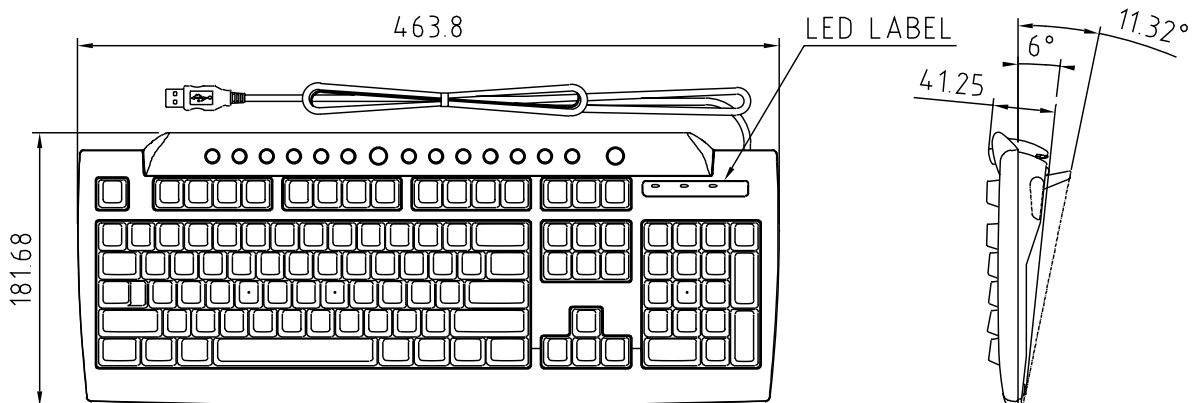

Terminals

Pin No.	Signal
1.	Vcc (+5V)
2.	-Data
3.	+Data
4.	GND

KEY LAYOUT

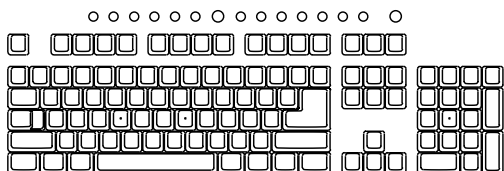

BIG ENTER 104 KEYBOARD

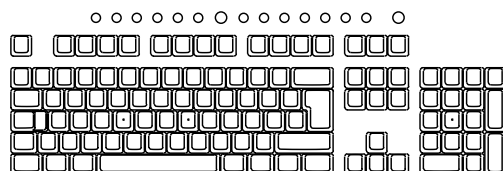

STANDARD ENTER 105 KEYBOARD

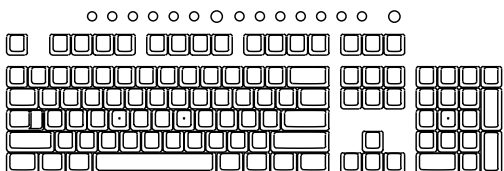

STANDARD ENTER 104 KEYBOARD

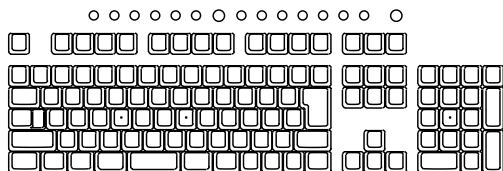

STANDARD ENTER 109 KEYBOARD